

Features

- 2-pin lead-less package
- Junction capacitance (Max value: 0.5pF)
- Peak Pulse current (8/20 μ s) Max:5A
- IEC61000-4-2 (ESD) \pm 15kV (air), \pm 15kV (contact)
- Low clamping voltage
- Low leakage current
- Working voltages:5V
- RoHS Compliant

Mechanical Characteristics

- Package: SOD-523
- Lead Finish:Matte Tin
- Case Material: "Green" Molding Compound.
- UL Flammability Classification Rating 94V-0
- Moisture Sensitivity: Level 3 per J-STD-020

Appearance & Symbo

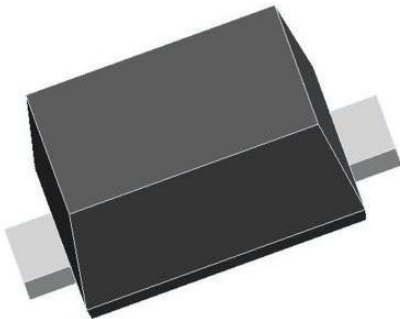

Applications

- Cellular Handsets and Accessories
- Personal Digital Assistants
- Notebooks and Handhelds
- Portable Instrumentation, Digital Cameras
- Peripherals, Audio Players, Industrial Equipment

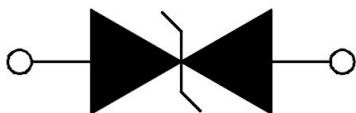

Bi-directional

Marking Information

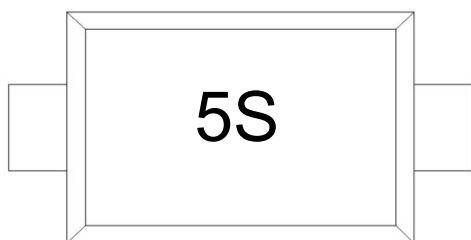

5S=Marking Code

Absolute Maximum Ratings (T=25°C, RH=45%-75%, unless otherwise noted)

Parameters	Symbol	Value	Unit
Peak Pulse Power (tp=8/20µs waveform)	P _{PP}	125	W
Peak Pulse Current (8/20µs)	I _{PP}	5	A
ESD per IEC 61000-4-2 (Air) ESD per IEC 61000-4-2 (Contact)	V _{ESD}	±15 ±15	KV
Operating Temperature Range	T _J	-55 to +125	°C
Storage Temperature Range	T _{stg}	-55 to +150	°C

Electrical Characteristics (T=25°C, RH=45%-75%, unless otherwise noted)

Parameter	Symbol	Test Condition	Min	Typ	Max	Unit
Reverse Working Voltage	V _{RWM}				5	V
Reverse Breakdown Voltage	V _{BR}	I _R = 1mA	6		10	V
Reverse Leakage Current	I _R	V _R = 5V			0.2	µA
Clamping voltage	V _C	I _{PP} = 1A, T _P =8/20us			12	V
Clamping voltage	V _C	I _{PP} = 5A, T _P =8/20us			25	V
Junction capacitance	C _J	V _R = 0V, f = 1MHz		0.3	0.5	pF

Typical Characteristics

FIG1: Power rating derating curve

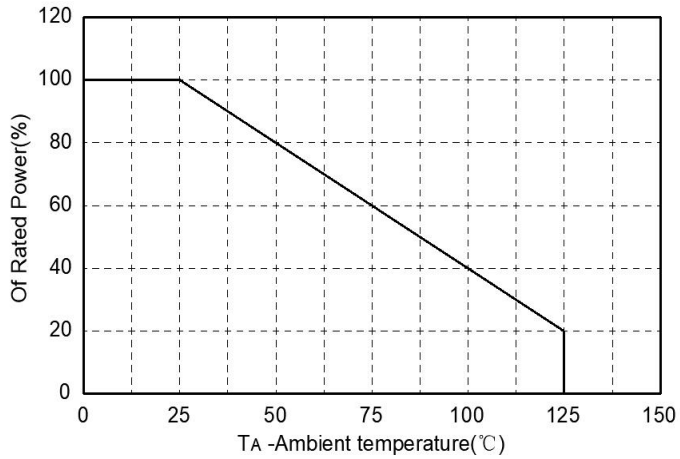

FIG2: pulse Waveform

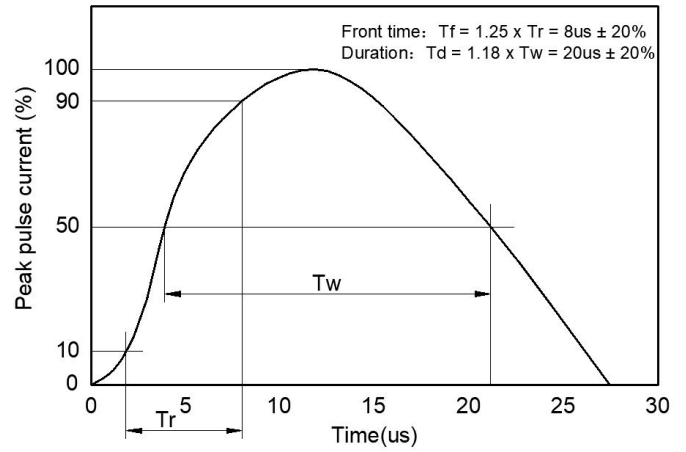

FIG3: Capacitance between terminals characteristics

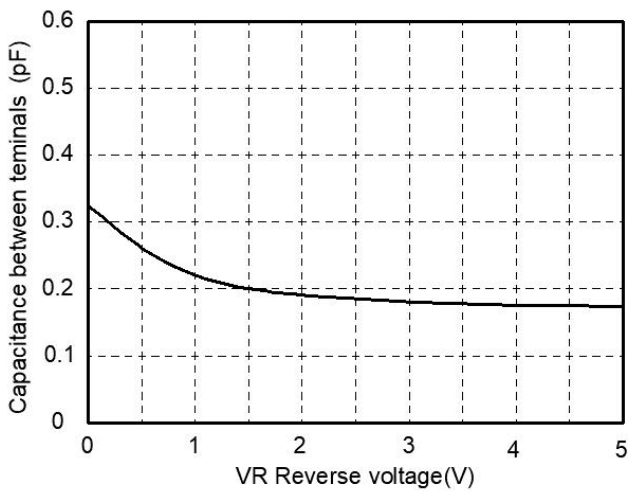
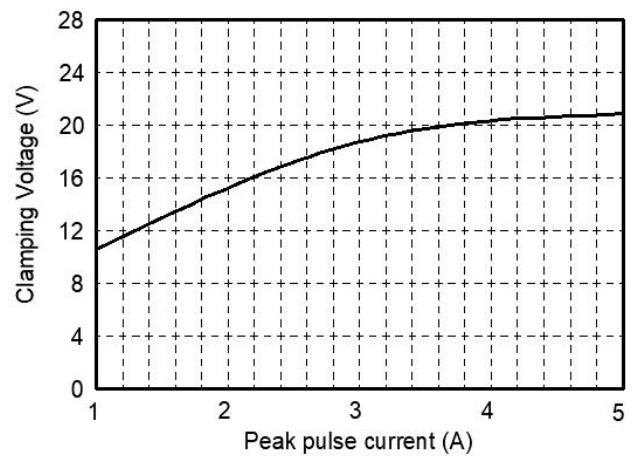
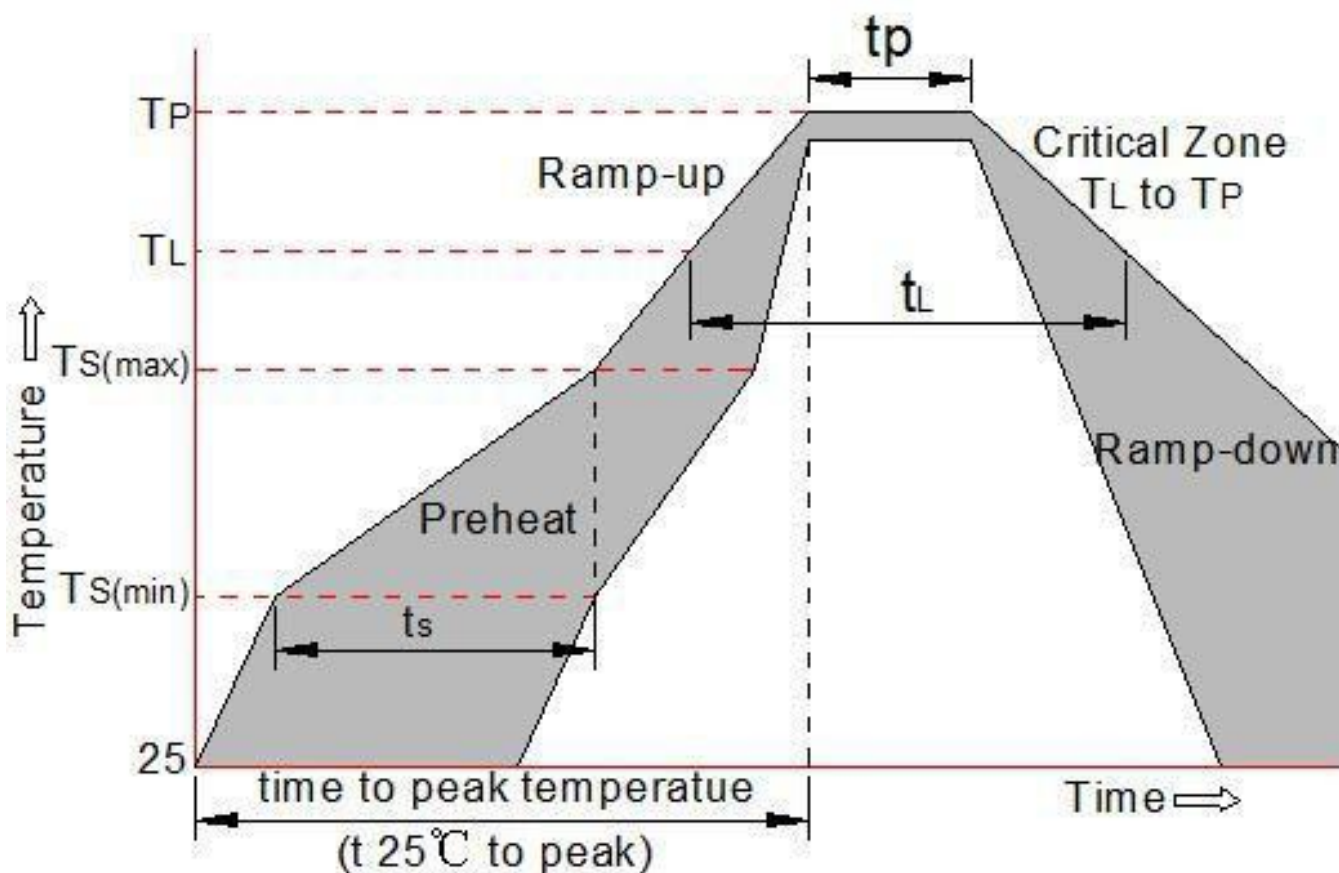

FIG4: Clamping Voltage vs. Peak Pulse Current



Soldering parameters

Reflow Condition		Pb-Free assembly see as bellow
Pre Heat	-Temperature Min ($T_{s(min)}$)	+150°C
	-Temperature Max($T_{s(max)}$)	+200°C
	-Time (Min to Max) (t_s)	60-180 secs.
Average ramp up rate (Liquid us Temp (T_L) to peak)		3°C/sec. Max
$T_{s(max)}$ to T_L - Ramp-up Rate		3°C/sec. Max
Reflow	-Temperature(T_L) (Liquid us)	+217°C
	-Temperature(t_L)	60-150 secs.
Peak Temp (T_p)		+260(+0/-5)°C
Time within 5°C of actual Peak Temp (t_p)		30 secs. Max
Ramp-down Rate		6°C/sec. Max
Time 25°C to Peak Temp (T_p)		8 min. Max
Do not exceed		+260°C



Package mechanical data

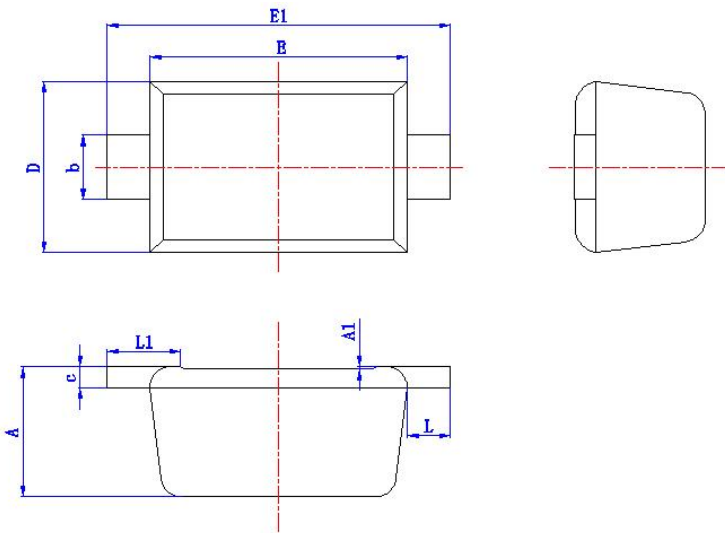

Symbol	Dimension in Millimeters	
	min	max
A	0.50	0.75
A1	0	0.05
D	0.68	0.95
E	1.10	1.35
E1	1.50	1.80
b	0.25	0.35
c	0.08	0.15
L	0.13	0.30
L1	(0.3)	

Suggested Land Pattern

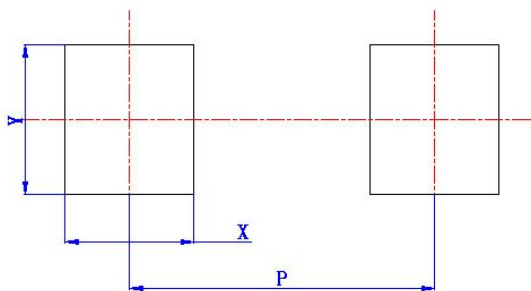

Symbol	Dimension in Millimeters	
	typ	
X	(0.6)	
Y	(0.7)	
P	(1.42)	